

REVISION HISTORY		
REV	DESCRIPTION	DATE
A	Initial Issue	07/09/2006

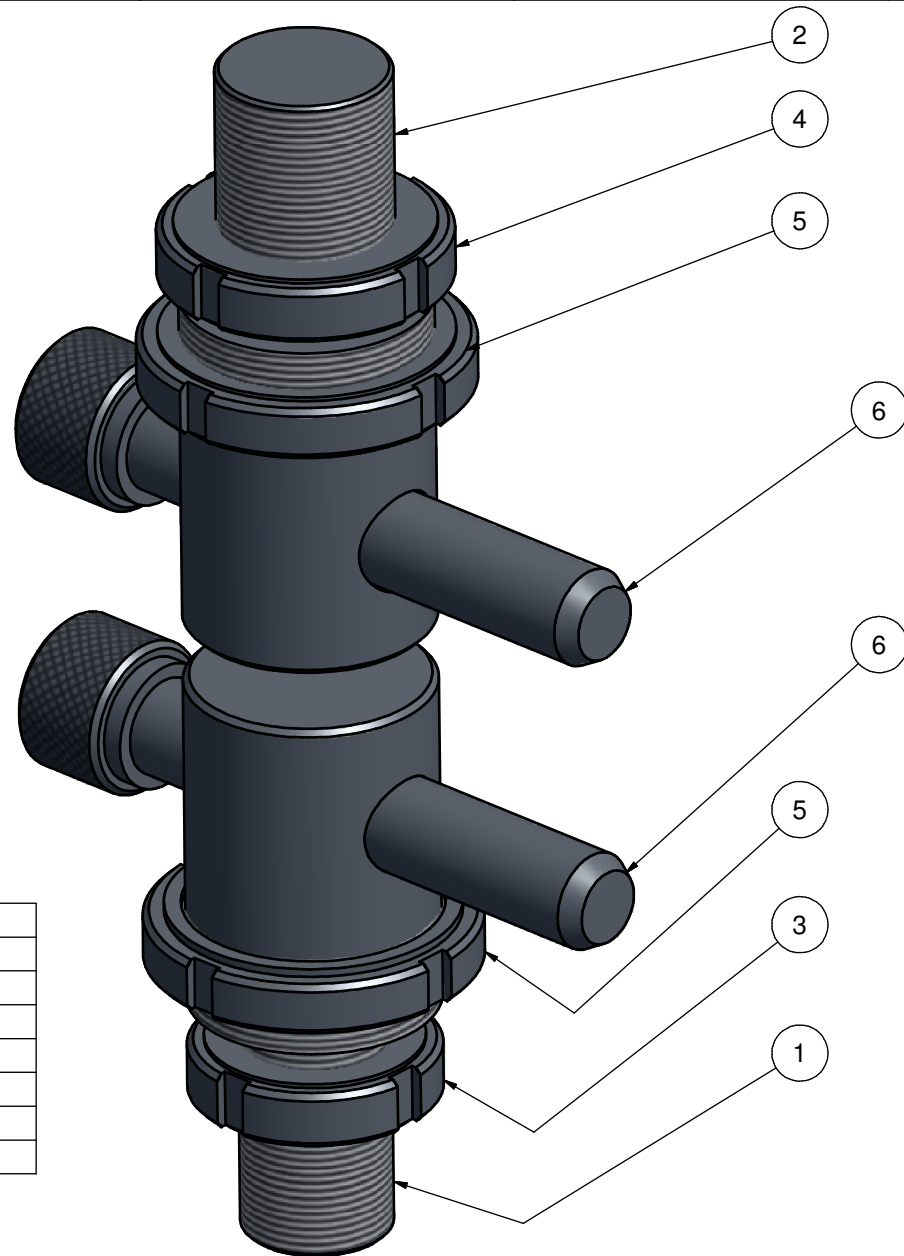

Parts List			
ITEM	QTY	PART NUMBER	TITLE
1	1	03-820-2834	Nosepiece - U Series - M36 / 60mm
2	1	03-820-2844	Nosepiece - U Series - M42 / 60mm
3	1	03-820-2851	Locking Ring - M36
4	1	03-820-2852	Locking Ring - M42
5	2	03-820-2854	Locking Ring - M60x2
6	2	03-820-2864	Cuck Pin - Dia 24 x 140

REMOVE ALL BURRS AND SHARP EDGES
ALL DIMENSIONS IN mm
SCALE (U.O.S.) 0.8 : 1
MATERIAL
FINISH --

TITLE
U Series Grip Fixing Kit - 60mm - M42 L'Cell



Tinius Olsen Ltd

© 2006

DO NOT SCALE
IF IN DOUBT - ASK

PROJECTION

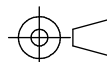

ISSUE
A

SHEET
1 OF 1

DIMENSIONAL TOLERANCES (U.O.S.)	
DECIMAL 0 D.P. +/- 0.40	FRACTIONAL +/- N/A
DECIMAL 1+ D.P. +/- 0.13	ANGULAR +/- N/A
DRAWN Nick Davy	DATE 07/09/2006
CHD.	APPD.
STORES	USED ON
DRG. NO.	98-820-1832

A3

A